



ATTENTION
OBSERVE PRECAUTIONS
FOR HANDLING
ELECTROSTATIC
DISCHARGE
SENSITIVE
DEVICES

arlight

ARL-4008UWC

Package Dimensions

Features

- Package (L/W/H) : 4.0 × 0.8 × 1.4 mm
- Color : Ultra Bright White
- Lens: Yellow Diffused Flat Mold
- EIA STD Package
- Meet ROHS, Green Product
- Compatible With SMT Automatic Equipment
- Compatible With Infrared Reflow Solder And Wave Solder Process

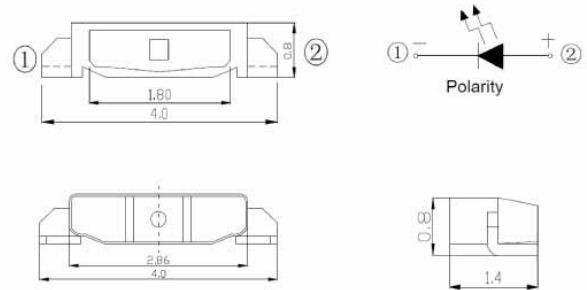

Description

- The ARL-4008UWC LED has side view and wide viewing angle and optimized light coupling by inter reflector. The low current requirement makes this device ideal for portable equipment or any other application where power is at a premium.

Soldering PAD Suggested.

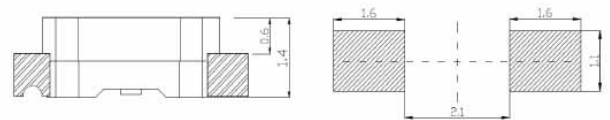

Usage Notes

Surge will damage the LED

When using LED, it must use a protective resistor in series with DC current about 20mA

Notes:

1. Other dimensions are in millimeters, tolerance is 0.25mm except being specified.
2. Protruded resin under flange is 1.5mm Max LED.
3. Bare copper alloy is exposed at tie-bar portion after cutting.

Applications

- Automotive: backlighting in dashboard and switch.
- Telecommunication: indicator and backlighting in telephone and fax.
- Flat backlight for LCD, switch and symbol.
- Light pipe application.
- General use.

Device Selection Guide

Part No.	Chip		Lens Color
	Material	Emitted Color	
ARL-4008UWC	InGaN	White	Water clear

Absolute Maximum Rating (T_a = 25°C)

Parameter	Symbol	Absolute Maximum Rating	Units
Forward Pulse Current (Duty 1/10 @1KHz)	I _F	100	mA
Forward Current	I _{FM}	30	mA
Reverse Voltage	V _R	5	V
Power Dissipation	P _D	120	mW
Operating Temperature	Topr	-40 ~ +80	°C
Storage Temperature	Tstg	-40 ~ +100	°C
Soldering Temperature	Tsol	Reflow Soldering : 260°C for 10 sec. Hand Soldering : 350°C for 3 sec.	°C

Electrical / Optical Characteristics at TA=25°C

Parameter	Symbol	Chip Rank	Min	Typ.	Max.	Units	Test Conditions
Luminous Intensity	I _v		1200	1500	1600	mcd	IF=20mA
Viewing Angle	2θ _{1/2}	---	---	120	---	Deg	(Note 1)
Chromaticity	X	---	0.24	0.29	0.38	nm	IF=20mA
	Y		0.28	0.32	0.368		
Spectral Line Half-Width	λ	---	---	---	---	nm	IF=20mA
Forward Voltage	V _F	---	3.0	---	3.6	V	IF=20mA
Reverse Current	I _R	---	---	---	10	μA	VR=5V

- Notes:** 1. Luminous intensity is measured with a light sensor and filter combination that approximates the CIE eye-response curve.
 2. θ_{1/2} is the off-axis angle at which the luminous intensity is half the axial luminous intensity.

Reliability Test Items And Conditions

No	Item	Test Condition	Sample Number	Criteria for Judging	Ac/Re
1	Solder ability	T=235±5°C T=5sec.	15	Good wetting	0/1
2	Soldering heat	T=260±5°C T=10sec.	15	IV≥LSL* VF≤USL* IR≤USL	0/1
3	Rapid change of temperature followed by: damp heat, cyclic	L:-40°C 10min (2~3) min H:+100°C 10min 5 cycle T=(25~55)°C RH:(90~95)% 2cycle 48h recovery time 2h	11	IV≥LSL VF≤USL IR≤USL	0/1
4	Damp heat, cyclic	T=(25~55)°C RH=(90~95)% 6 cycle 144h recovery time 2h	11	IV≥0.7LSL VF≤1.1USL IR≤2USL	0/1
5	Electrical endurance	I _F =30mA T=1000h	22	IV≥0.7LSL VF≤1.1USL IR≤2USL	0/1
6	Storage at high temperature	T _{stg} =100±2°C t=1000h	15	IV≥LSL VF≤USL IR≤USL	0/1
7	Terminal strength	Tensile: W=5N t= 30s Bending: W=2.5N 2times	15	No damage	0/1

*U.S.L.: Upper Standard Level

* L.S.L.: Lower Standard Level

Soldering Profile Suggested

● For Lead Solder

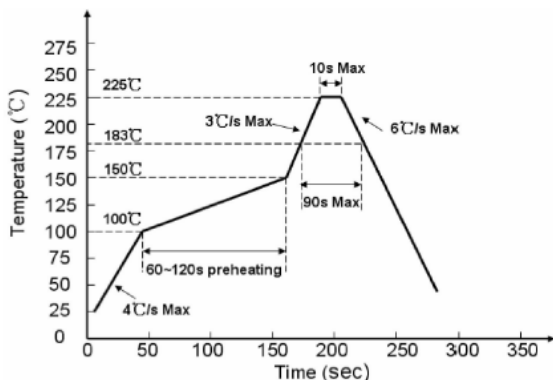

● For Lead Free Solder

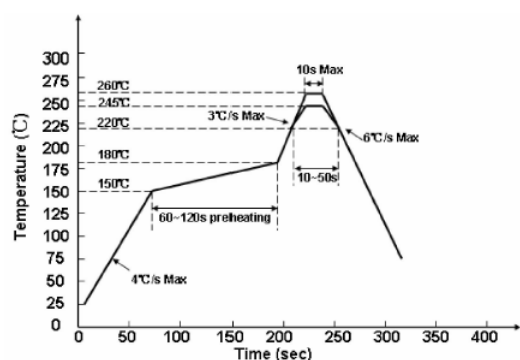

Notes:

We recommend the soldering temperature 245± 5°C ;

The maximum temperature should be limited to 260 °C.

Reel And Tape Dimensions

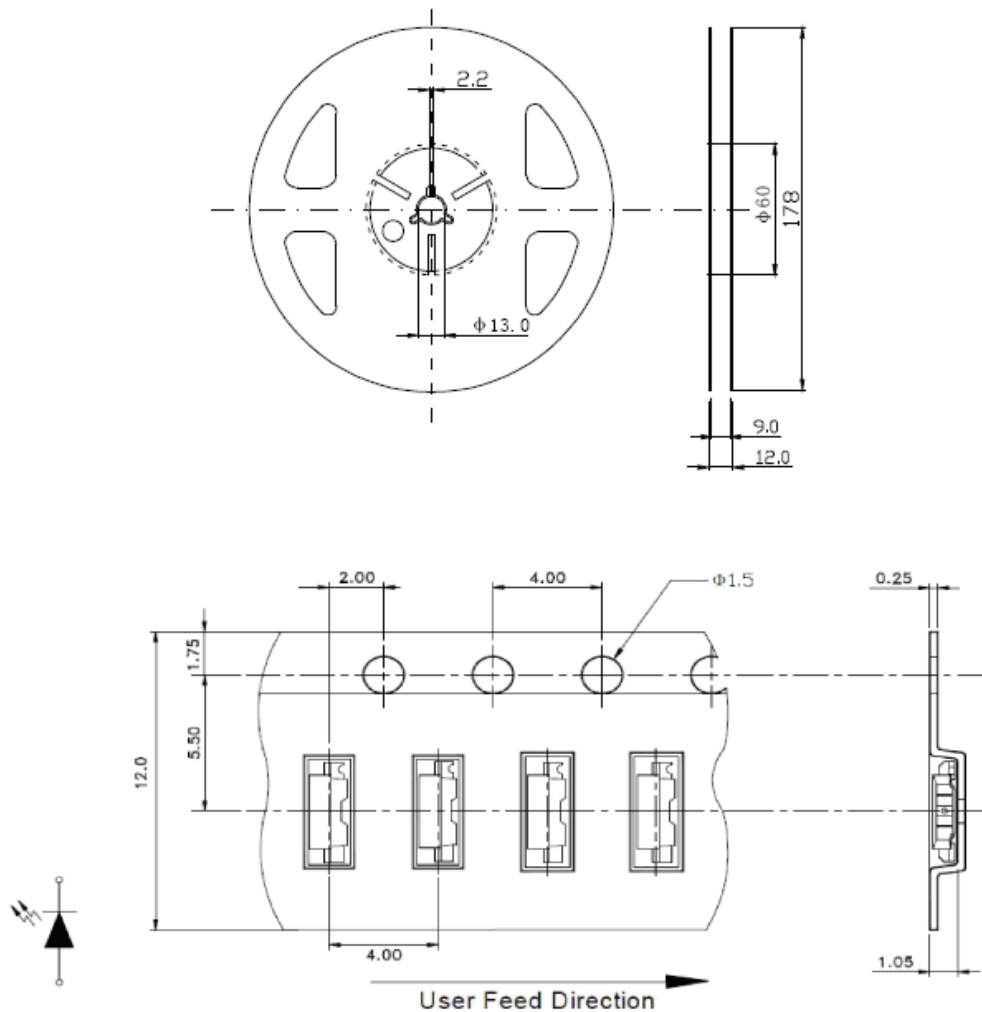

- Notes:** 1. All dimensions are in millimeters.
2. Tolerance is ± 0.1 mm unless otherwise noted.

Cautions

Application

1. A LED is a current-operated device. The slight shift of voltage will cause big change of current, which will damage LEDs. Customer should use resistors in series for the Over-Current-Proof.
2. In order to ensure intensity uniformity on multiple LEDs connected in parallel in an application, it is recommended to use individual resistor separately, as shown in Circuit A below. The brightness of each LED shown in Circuit B might appear difference due to the differences in the I-V characteristics of those LEDs.

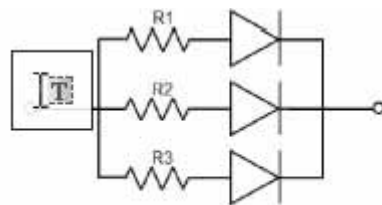

Circuit model A

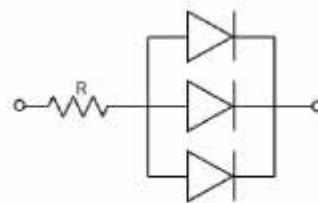

Circuit model B

3. High temperature may reduce LEDs' intensity and other performances, so keeping it away from heat source to get good performance is necessary.

Storage

1. Before opening original package, it is recommended to store them in the following environment: Temperature: $5^{\circ}\text{C} \sim 30^{\circ}\text{C}$ Humidity: 85%RH max.
2. After opening original package, the storage ambient for the LEDs should be in $5 \sim 30^{\circ}\text{C}$ temperature and 60% or less relative humidity.

3. In order to avoid moisture absorption, it is recommended that the LEDs that out of the original package should be stored in a sealed container with appropriate desiccant, or in desiccators with nitrogen ambient.
4. The LEDs should be used within 168hrs (7 days) after opening the package. Once been mounted, soldering should be quick.
5. If the moisture absorbent material (silica gel) has faded away or the LEDs stored out of original package for more than 168hrs (7 days), baking treatment should be performed using the conditions: 60 at least 24 hours.

ESD (Electrostatic Discharge)-Protection

A LED (especially the Blue, White and Green product) is an ESD sensitive component, and static electricity or power surge will damage the LED.

ESD-damaged LEDs will exhibit abnormal characteristics such as high reverse leakage current, low forward voltage, or "no light-up" at low currents, etc.

Some advice as below should be noticed:

1. A conductive wrist strap or anti-electrostatic glove should be worn when handling these LEDs.
2. All devices, equipment, machinery, work tables and storage racks, etc. must be properly grounded.
3. Use anti-static package or boxes to carry and storage LEDs. And ordinary plastic package or boxes is forbidden to use.
4. Use ionizer to neutralize the static charge during handling or operating.
5. All surfaces and objects within 1 ft close to LEDs measure less than 100V.

Cleaning

Use alcohol-based cleaning solvents such as IPA (isopropyl alcohol) to clean LEDs if necessary.

Soldering

1. Soldering condition refer to the draft "Soldering Profile Suggested" on page 1.
2. Reflow soldering should not be done more than 2 times.
3. Manual soldering is only suggested on repair and rework. The maximum soldering temperature should not exceed 300°C within 3 sec. And the maximum capacity of soldering iron is 30W in power.
4. During the soldering process, do not touch the lens at high temperature.
5. After soldering, any mechanical force on the lens or any excessive vibration shall not be accepted to apply, also the circuit board shall not be bent as well.

Others

1. The LEDs described here are intended to be used for ordinary electronic equipment (such as office equipment, communication equipment and household applications). Consult Sales in advance for the applications in which exceptional reliability is required, particularly when the failure or malfunction of the LEDs may directly jeopardize life or health. (such as in aviation, transportation, traffic control equipment, medical and life support systems and safety devices).
2. The light output from the high luminous intensity LEDs may cause injury to human eyes when viewed directly.
3. The appearance and specifications of the product may be modified for improvement without prior notice.